

P-40N

ALMOST READY TO FLY



Features:

- Heavy duty fiberglass fuselage with molded panel lines
- Balsa and ply wing covered and painted
- Pin hinges for all control surfaces
- Hand Painted fiberglass cowl
- Quality USA made 4-40 hardware included
- Extra-heavy duty fiberglass accessories
- Designed for retracts on main and tail
- Instrument panel kit
- 5-1/2" Machined aluminum spinner
- Quick-Align engine mounting system



Specifications:

Wingspan:..... 82 inches
Length:..... 71 inches
Wing Area:..... 1190 Sq. in.
Weight:..... 19 - 23 lbs
Engine:..... 45 - 65cc gasoline
Radio:..... 6 channel minimum
Scale: 1/5.5



Skyshark R/C Corporation

1924 N. Pima Drive • Lake Havasu City, AZ 86403, U.S.A.

Phone: (928) 854-6100 • Toll Free: 1-866-854-6100

Fax: (928) 854-6111

Website: www.skysharkrc.com
email: custserv@skysharkrc.com

Thank you for purchasing the P-40N ARF from Skyshark R/C. For the first time, R/C enthusiasts have a choice in good quality scale aircraft designs. Good looks and flying characteristics, and a uniqueness that is sure to turn heads wherever you take your airplane!

Covering

When you receive the P-40, there will normally be some loose or wrinkled covering. This is due to climate changes that take place during shipping. The parts are covered in low temperature Solartex so they don't require a lot of heat to remove wrinkles. The best way to tighten the covering is with a heat gun set for low heat. Hold the gun about 6" away from the covering and move it in fast circles around the parts. Be careful, too much heat in one place at one time will damage the covering or paint.

The Skyshark P-40N is painted with fuel proof 2-part paint. We have tested it using 25% nitro and standard gasoline. If you would like to do additional weathering and detailing, we have found that it is compatible with most other fuel proof paint. If you plan to add details, we recommend you use a piece of the canopy that was cut off to ensure paint compatibility.

CAD Design

CAD design allows strength to be built into the airplane without sacrificing weight. Because of this, we were able to make the P-40 lighter than most current airplanes of this type.

Plastics and Fiberglass

The cowl is accurately reproduced in fiberglass and painted to match the fuselage. The shark mouth is hand painted using fuel proof paint. Engines should be mounted inverted to best hide them and for adequate cooling. The canopy is accurately reproduced in clear plastic and painted to match. Use care when trimming the canopy because the paint makes them fragile. Use a canopy scissors to trim close to the lines, then use a rotary sander to remove the rest.

Engine Options

Engine choices range from 45 - 65cc. We used a Zenoah G45 and Revolution 50 in our prototypes. Balance was right on with either engine but the cowl had to be cut away in order to fit the Zenoah carb and exhaust.

Cockpit Detail

A fully detailed laser cut and engraved instrument panel is included in the kit. It does require some simple assembly but detailed instructions are provided.

Repairs and Replacement Parts

Repairs can be made easily using readily available plywood, balsa and Solartex or other fabric type covering.

Matching paint can be purchased from us. If you would like to purchase replacement parts, please call our customer service line at 1-866-854-6100. We will be happy to assist you with anything that you need.

General Building Information

The Skyshark P-40 was designed to be assembled and flown by someone with previous giant scale airplane experience. This instruction manual may leave out some basic steps that are common to all model airplane assembly. Please read the manual completely before beginning assembly. Once you begin assembly, you will not be able to return the plane for a refund if you decide it is too difficult.

Occasionally hints will be included at certain building steps. These are not required for completion, rather they are tips intended to ease a particular process.

All hardware needed to complete the P-40 is included in the kit. The pushrods and clevises are 4-40. The other hardware is USA made in SAE sizes. If you need replacements, any 4-40 clevises or pushrods will work.

We have flown this plane using 60 oz. in. servos in the ailerons, flaps and elevators without any problems. If you feel more comfortable, you are welcome to use servos with higher torque ratings. A high torque metal gear servo **MUST** be used on the rudder.

This aircraft is not a toy. It must be flown in a responsible manner according to the rules set forth by the Academy of Model Aeronautics. The builder assumes the responsibility for the proper assembly and operation of this product. Skyshark R/C shall have no liability whatsoever, implied or expressed, arising out of the intentional or unintentional neglect, misuse, abuse, or abnormal usage of this product. Skyshark R/C shall have no liability whatsoever arising from the improper or wrongful assembly of the product nor shall it have any liability due to the improper or wrongful use of the assembled product. Skyshark R/C shall have no liability for any and all additions, alterations, and modifications of this product.

Before beginning assembly: Check all components for shipping damage. Be sure to look inside the fuselage and wings at the servo bay locations for any hidden damage. If you notice any damage, notify us immediately for replacement parts. **Also check all formers inside the fuselage to insure they are secured properly to the fiberglass.** If you find any weak areas, sand the area and use 5 min epoxy to secure the formers. You can also add some 1 oz. fiberglass cloth for extra reinforcement. This is especially important in the firewall and tail gear area.

Having said that mouthful, it's time to start building the best airplane on the market!

Items needed to complete your P-40N ARF:

Thin CA glue
Medium CA glue
Thick CA glue
5 minute epoxy
30 minute epoxy
Epoxy brushes
Red threadlocking compound
RC-56 canopy glue
Masking tape
Fuel Tubing
EZ fueler or fueling dots
Rubber Bands
Misc. tools for building including: Screwdrivers, hex wrenches, pliers, scissors, sandpaper, files, etc.
Battery

Retractable main gear (Sierra Giant Scale or other)
Retractable tail gear (Sierra Giant Scale or other)
Air control kit
(2) 5.5" Heavy duty main wheels
(1) 2" Heavy duty tail wheel
(2) Standard servos (throttle & retract valve)
(6) High torque servos (61 oz. or higher)
(1) High torque metal gear servo (120 oz. or higher)
(7) Extra long servo arms
(2) 12" Servo extensions
(5) 24" Servo extensions
(2) Sullivan S517 pushrods (optional center servo)
(1) 4-40 Pull-pull setup (option center servo)
(1) Tru-turn spinner adapter to fit your motor
Y-harness - up to 4 (optional)

Flying:

None of the prototypes weighed over 21lbs., though the weight range specified allows for more individual variations.

Ground handling is typical of any short coupled airplane. Advance the throttle slowly and be sure to stay on the rudder or you will experience ground looping.

There is nothing out of the ordinary to note about takeoffs. Advance the the throttle slowly and let the plane build up speed. It will lift off with very little elevator input. Be careful while using the rudder in the air. Too much rudder will cause the plane to stall and go into a spin.

Landings should be done with a low throttle setting and flaps. Be careful not to use too much rudder on landing or the plane will tip stall. The best way to land is line the plane up and let it drift down while keeping a slow throttle setting. Use as little rudder as possible to keep the airplane flying straight. The wing is designed to help reduce tip stalls at lower speeds. Due to this, the Skyshark P-40 can be landed a little slower than most other P-40s in this size range. Be careful of too much landing speed or the plane will nose over once the wheels touch the ground.

Windy conditions: Do not attempt to fly in a high crosswind unless you are very comfortable with the characteristics of the plane. In the air, you won't notice the wind but during landing, the airplane will tend to weathervane and require a lot of rudder. (see my previous rudder on landing warning!) Landing in head wind is no problem and is actually preferred!

Notes:

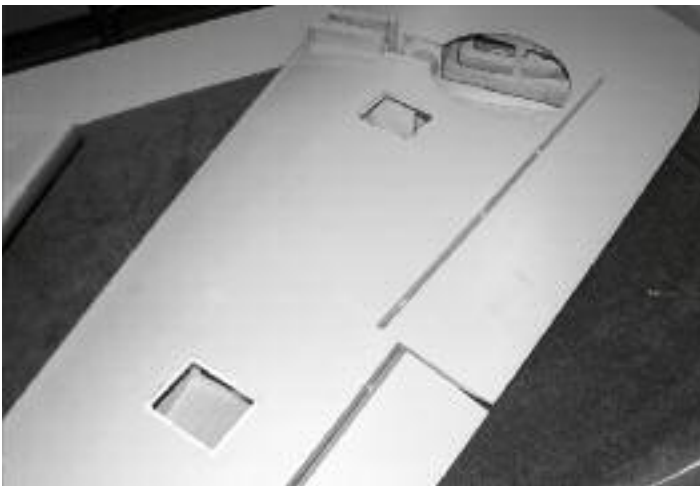

1. Move your hand over the bottom of the wing surface to locate the wing cutouts for the servo trays and wheel wells. Remove the covering in those areas using a hobby knife.

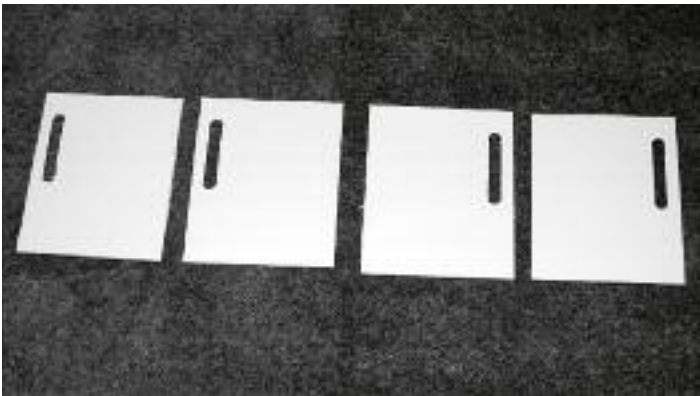

2. Locate the 4 wing servo covers and remove the covering from the slots using a sharp hobby knife.



3. Test fit the servo covers in the wing holes. The slots in the wing covers should be positioned as shown in the photo. This will insure that the pushrods line up with the hardwood blocks in the ailerons and flaps.

To make servo mounting easier and more secure, you can use Sierra Giant Scale P112 aluminum servo mounts. These are available from Skyshark or Sierra Giant Scale.

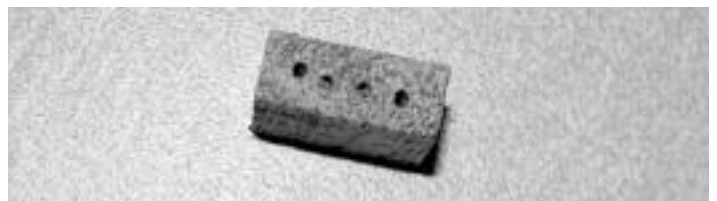
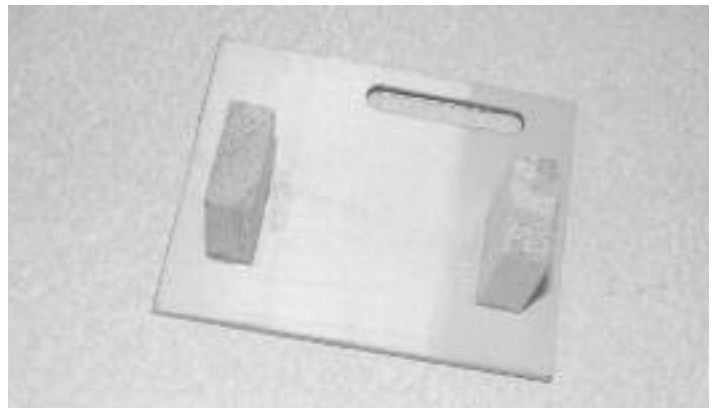

4. Align the servo on the servo cover so the arm is centered in the slot. Glue the mounting blocks to the servo cover as shown using 5 min epoxy. Note: you can also drill some small 1/16" holes in the blocks on the side that attaches to the cover. This will help the epoxy bond better.

Mount the servos as shown. Use long enough servo arms so you will clear the top of the servo hatch by 1/2" min.

Note: All control surfaces are pre-hinged, however, the hinges are not glued in place. All hinges should be glued in place using high quality epoxy or Pacer Hinge glue.

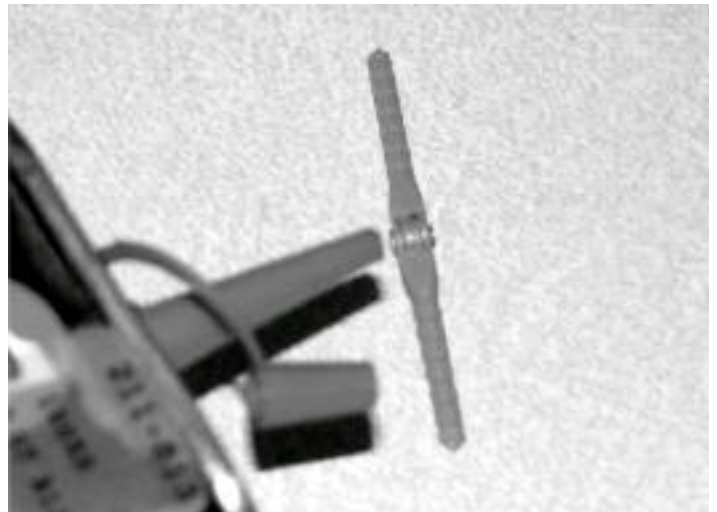

5. Remove the flaps and place a drop of oil on the joint of each hinge. This will keep the epoxy from getting into the hinge joint when they are glued in place.



6. Insert the hinges into the flap and trailing edge of the wing. Check for proper alignment and operation of the flap. Realign the hinges as necessary. Note: The hinges will be inset into the flap leading edge so the gap will be minimized.



7. Apply a small amount of 5 min epoxy to one side of each hinge and insert the hinge into the flap. Apply a small amount of epoxy to the other side of the hinge. Insuring the hinges operate in the correct direction, insert the flap/hinge assembly into the holes in the wing trailing edge. Tape the flap in place and allow the epoxy to dry. There should be less than a 1/16" gap between the flap and trailing edge of the wing.

Repeat the above process for the other flap.

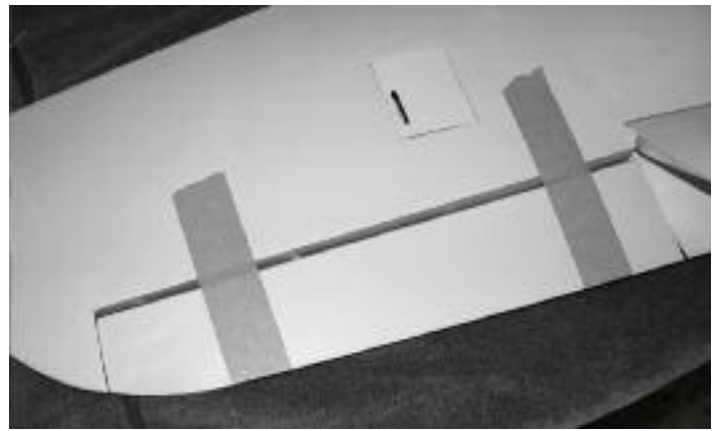

8. Install the aileron hinges using the same method as the flaps. Note: The hinge joint will be inset in the aileron leading edge in order to minimize the gap. There should be less than 1/16" gap when attached.

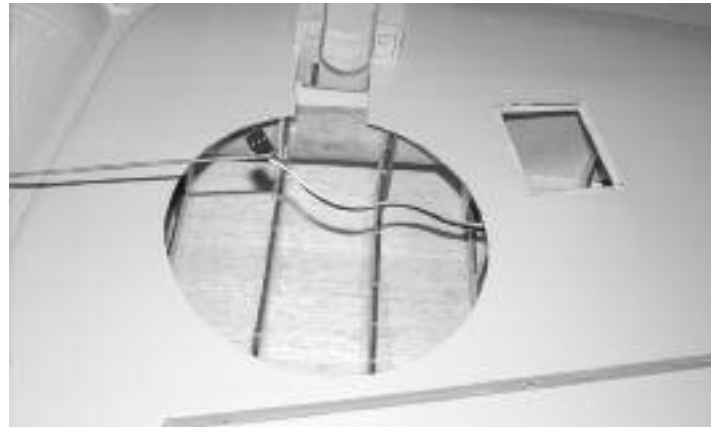

9. Connect a 12" extension to the aileron servo and place the servo in the hatch as shown. Use a long piece of wire to fish the servo extension through the wing and out the hole in the top center of the wing. You can locate the wing hole by looking through the end rib.

Before fastening the servo hatches in place, it's a good idea to make sure the servos are properly centered and the arms are in the correct position for maximum control movement.



10. Use a 1/16" drill bit to drill holes in the servo hatch and mounting plate as shown. Make sure to drill close enough to the edge of the hatch so you also drill into the mounting blocks below. Secure the hatch using (6) #2 x 3/8" button head screws.

Repeat for the other aileron and flap servo hatches.

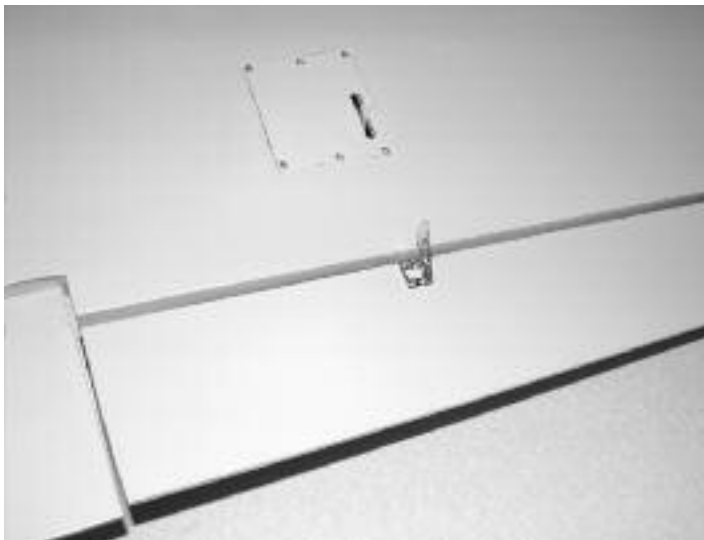

11. Locate a 3/4" metal control horn on the aileron by using a pushrod to align it with the servo arm. The control horn should be located where the leading edge bevel begins. There will be a hardwood block in the correct location.



12. Mark the location of the control horn. Remove the horn and drill four 3/32" holes at the marked locations. Use the enclosed 2-56 x 1.5" screws to attach the control horn to the elevator and backplate.

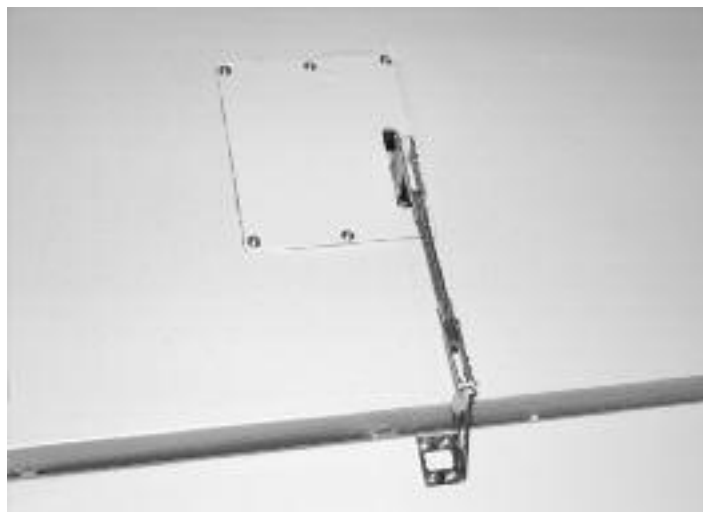

13. With the control surface centered attach a 4-40 clevis to the servo arm and control horn. Measure and cut a piece of 4-40 threaded rod to the correct length. You can either solder one clevis onto the control rod or use the enclosed 4-40 nuts to secure them onto the pushrod. If you don't solder, use thread locker to secure the locknuts in place once they are tight against the clevis.

14. Connect the control rod assembly to the servo arm and clevis. Adjust for proper centering and movement of the control surface. Note: You may need to enlarge the holes in the servo hatch for full control surface deflection.

15. Repeat for the other aileron.



16. Repeat the same procedure for the flap controls. Be careful when drilling into the flap so that you don't drill through the top of the wing!

Wing Joining



17. Fit the aluminum tube in the wings and assemble the wing halves to check for a good fit. Sand or adjust the root ribs as necessary so there are no gaps.



18. Apply masking tape around the root ribs of each wing half in order to keep epoxy from getting on the wing when the wings are assembled.

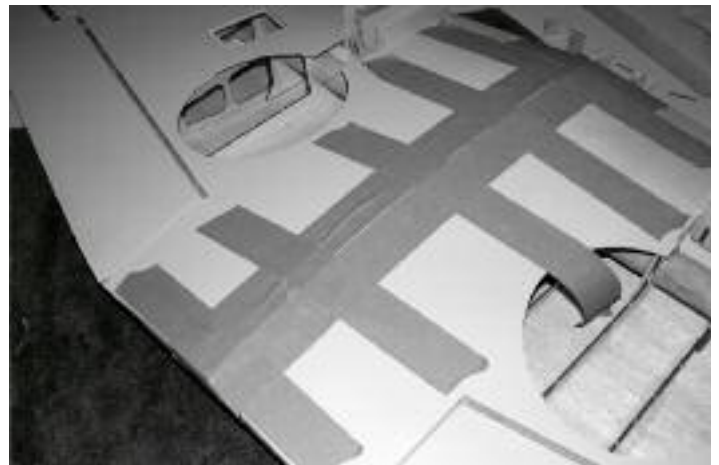

19. Apply a light coat of 30 min epoxy to one half of the wing tube and slide into one wing half. Apply epoxy to the other end of the tube and to both root ribs.

20. Join the wing halves, making sure that they are parallel and there are no gaps. Wipe off any excess epoxy with denatured alcohol. Secure the wing halves with masking tape and set aside to dry.

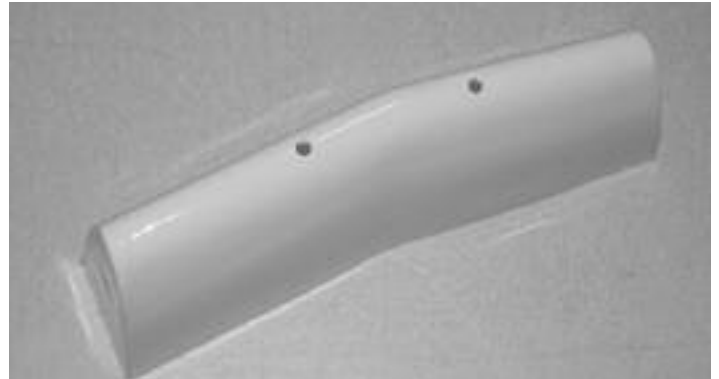

21. Once the epoxy has cured, locate the leading edge wing dowels by using the enclosed template. Using a hobby knife, cut two 1/4" holes in the front of the template at the molded locations.

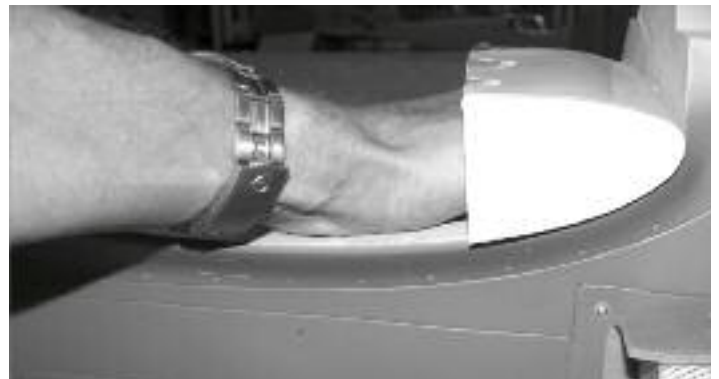

22. Place the template onto the fuselage so the crease is facing up. Make sure it is flush against the wing saddle and with the front dowel mounting plate. Mark the location of the wing dowel holes. Be careful not to flex the template when marking the hole or the wing will not align correctly.

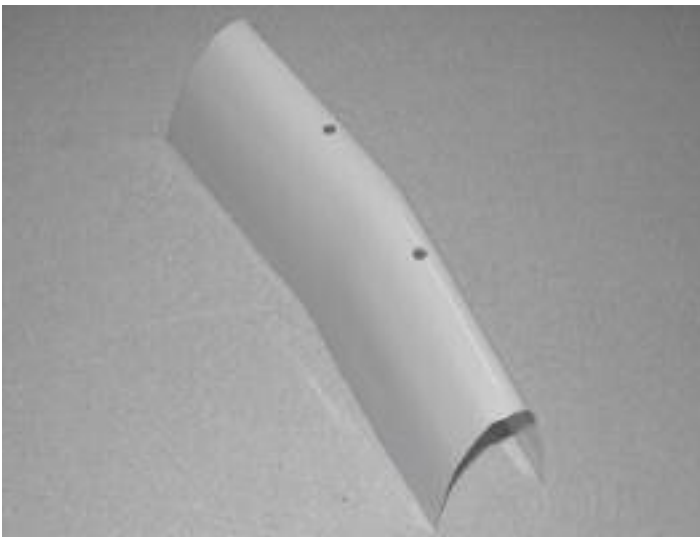

23. Cut off the sides of the template at the molded lines.

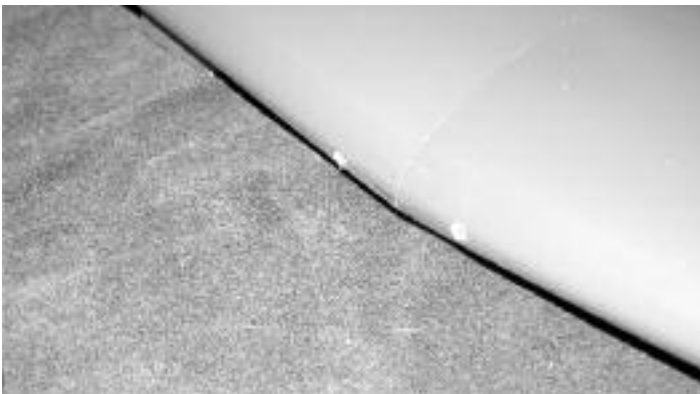

24. Fit the template to the leading edge of the wing and mark the hole locations. Remove the template and drill two **STRAIGHT** 1/4" holes at the marked locations.

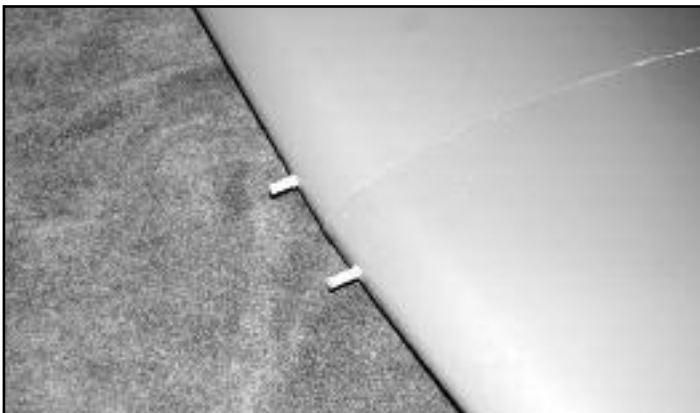

25. Use 5 min epoxy to glue the wing dowels into place. Insure the dowels extend 5/8" from the wing leading edge.



26. Place the wing on the fuselage and double check the wing dowel alignment. Once everything is aligned, drill two 1/4" holes in the fuselage wing dowel plate at the marked locations.

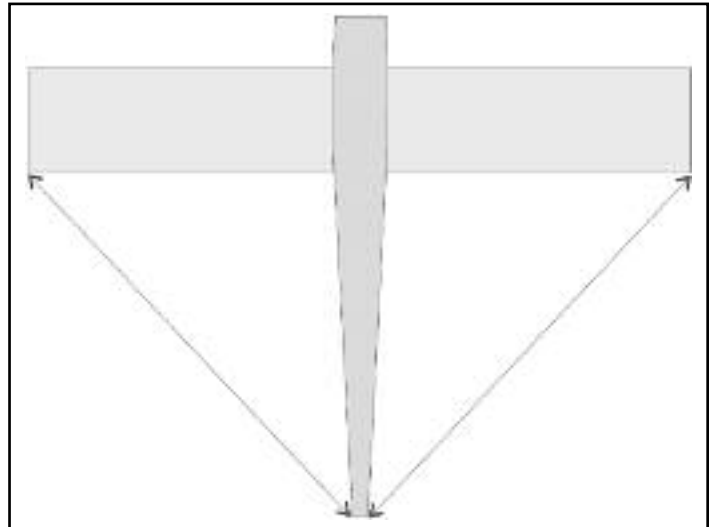

27. Align the wing to the fuselage as shown and mark its location.



28. With the wing centered, measure 2-1/2" over from the flap and 1" up from the wing trailing edge. Make a mark in this location on each wing half.



- 29. Drill a 1/4" hole through the wing and wing mounting plate at the marks made in the previous step. Insure the drill is straight and the wing is aligned and held securely in place.



- 30. Enlarge the fuselage wing mounting plate holes to 19/64" and install the 1/4-20 metal blind nuts securely on the back side using CA or epoxy. Note: Do not use the nylon 1/4-20 bolts to set the blind nuts in the plywood because they are not strong enough. The best way is to use a spare 1/4-20 metal bolt or strong pliers.

Belly Pan Mounting: The belly pan is made using very heavy duty fiberglass and is very inflexible. We made it extra rigid so it won't collapse if you lift the plane by the belly pan or have a gear up landing. Due to this, every belly pan may not match the wing contour exactly. We have listed some steps to make for a better fit.



- 31. Bolt the wing to the fuselage and test fit the belly pan to the center of the wing bottom

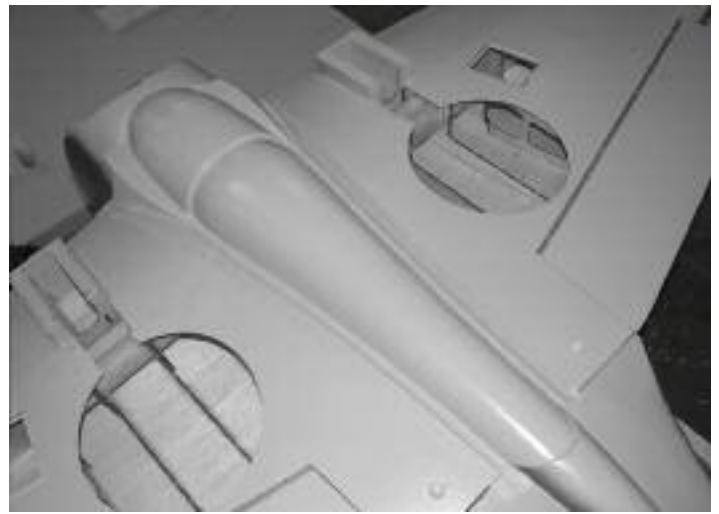

- 32. If your belly pan doesn't fit exactly (turned up edges, wrong contour, etc) you can adjust it by taping the edges with masking tape and using a heat gun to soften the fiberglass while carefully pressing it into place with a gloved hand. You may need to go over it a couple times, letting it cool in between. Note: Be careful not to bend the fiberglass too much while it is cool or the paint will crack.



- 33. Once you have a good fit, remove the tape on one side of the belly pan and mark a line on the wing at the edge of the belly pan. Repeat for the other side.



34. Remove the belly pan and use a pin to poke holes in the covering along the inside of the lines you just made.

If you feel more comfortable, you can, instead, remove the covering along the lines. We use the pin hole method because it's difficult to align the small lip on the belly pan exactly to the cut lines.



35. Sand the edges of the belly pan with 100 grit sandpaper to remove any mold release or high spots and clean with rubbing or denatured alcohol. Also clean the wing with denatured alcohol in the area that was marked in the previous steps.



36. Apply 5 or 30 minute epoxy to each mounting edge and fit the belly pan to the wing. Apply weight to the belly pan until the epoxy has cured. We use socks filled with lead shot for this task but magazines or plastic bags filled with sand also work.

37. Once the epoxy has cured, you can seal the edges with a fillet of epoxy. You can also re-heat the fiberglass with a heat gun to make any stray edges lay smoothly against the wing.

Cut 2" off each end of the plywood wing bolt mounting plate and align the holes in the plate to the bolt holes in the bottom of the wing. Epoxy each plate over the wing holes to reinforce the bolt area.

Tail Surfaces

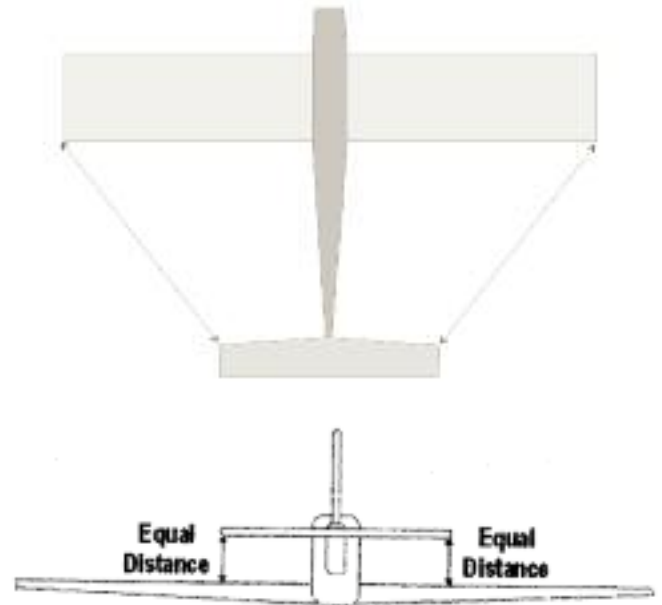

38. Insert the horizontal stab into the fuselage slot and align it with the wing as shown in the diagram



39. Draw a line on each side of the stab where it meets the fuselage. Do this on the top and bottom of the stab.

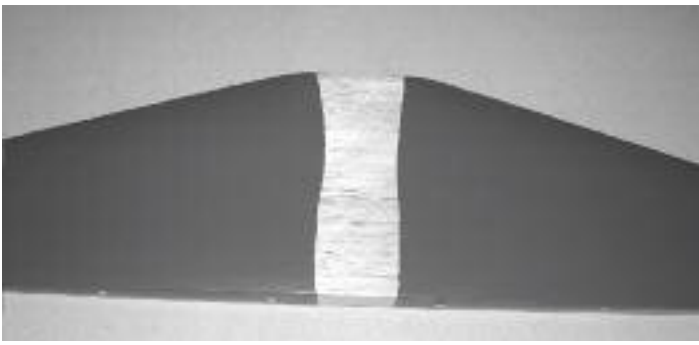

40. Remove the stab and carefully cut the covering about 1/16" inside of the lines you just made. Remove the covering. Be careful not to cut into the balsa sheeting

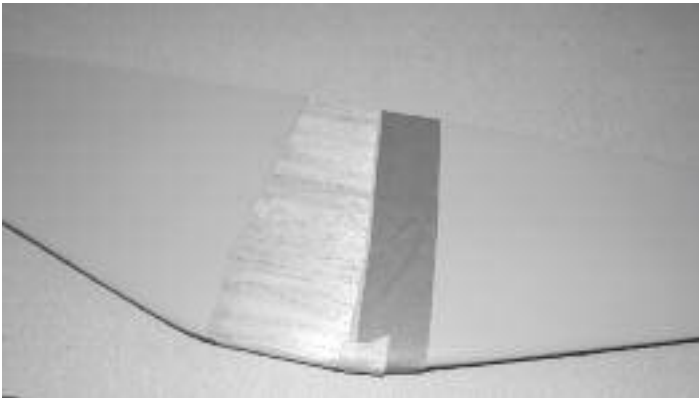

41. To make epoxy cleanup easier, apply masking tape to the fuselage and stab as shown. Sand the elevator saddle with 100 grit sandpaper to remove the existing paint and primer. This will help the elevator bond to the fuselage.



42. Apply a 1/2" wide strip of 5 or 30 min epoxy to the inside of the line you made on each side of the horizontal stab.

43. Slide the stab into the fuselage hole. Align with the marks made previously and insure that it is level with the wing. Secure in place with masking tape and allow the epoxy to cure.



44. When the epoxy cures completely, remove the masking tape and inspect the stab to insure it is well glued. If there are any missed spots, apply epoxy to fill the gap. You can clean up any additional epoxy with denatured alcohol. Note. You can access the bottom of the stab through the tail wheel retract area. Apply a thin layer of epoxy to the stab in this area insure everything is secure.

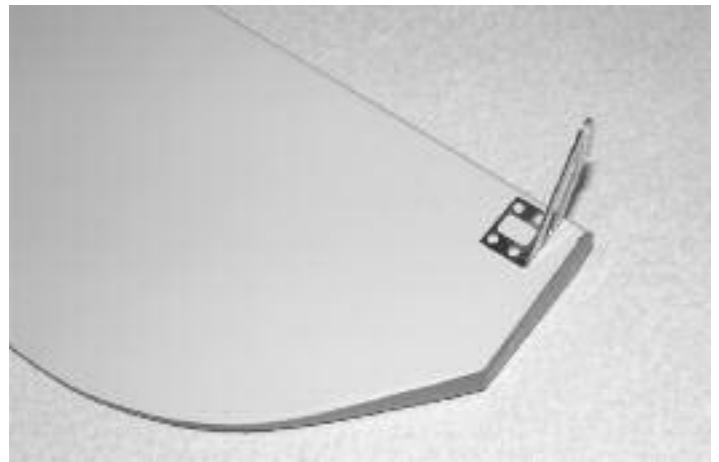

45. Place a 1-1/8" control horn 1/8" from the inner edge of one elevator half. Mark the four screw locations. Remove horn and drill four 3/32" holes at the marked locations. Note: There will be hardwood blocks in this location.



46. Attach the control horn to the backplate using four 2-56 x 1-1/2" screws. Repeat for the other elevator half. Note: Make sure the control horns are in the same location on each elevator half.



47. Hinge the elevators to the H stab using the same method as was used with the ailerons. Tape in place and allow the epoxy to cure.

Engine Mounting - Revolution 50

In this section, we discuss installation of the Revolution 50 gas engine. We chose this engine because the narrow design and special muffler fits well in the cowl. You can install any similar sized engine by following our instructions for the Revolution 50.

Before mounting the engine, it's a good time to check the fit of the fuel tank in the engine box. You may need to sand the sides of the box so the fuel tank will fit in the opening.



48. Extend out the center lines on the firewall box as shown. Note: The center hole will be near the top of the box. When mounting the motor inverted, insure that the mount is on the firewall correctly.



49. Use a pencil to mark the centerline on the sides of the engine mount. The centerline will be in line with the cross section on the back of the mount.



50. Center the engine mount on the firewall box with the marks made in the previous step.



51. With the engine mount aligned, use a 7/32" drill bit to mark the bolt holes on the firewall box.

52. Remove the mount and drill four 15/64" holes in the firewall.

53. Install four 10-32 blind nuts in the back of the firewall and check to make sure they do not extend through the front of the firewall. If they do, see step 54.

Use med CA to glue the blind nuts in place.



54. Install the motor and mount onto the firewall. Note: you may need to drill out the mount bolt holes to $15/16$ " because sometimes the blind nuts will extend through the firewall a little. Either that, or you can epoxy a piece of $1/8$ " ply to the back of the firewall before installing the blind nuts. This will increase the thickness of the firewall so the blind nuts don't extend all the way through.

55. Now is a good time to apply a little extra epoxy to the joints on the inside of the firewall box. This will insure that vibration will not break the firewall box apart.

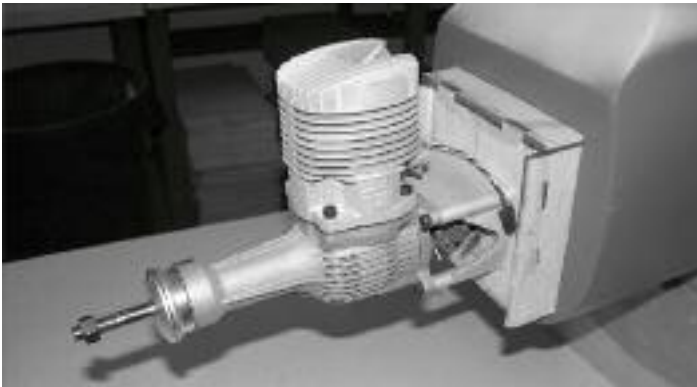

56. Slide the firewall box into the fuselage and tape the cowl in place along the molded lines on the fuselage



57. Attach the spinner backplate and prop to the engine and align the backplate with the front of the cowl. There should be a $1/8$ " gap between the spinner backplate and the front of the cowl. Note: You will be able to move the engine box slightly to center the engine. If you can't adjust the engine box as much as is required, then you may need to make a small adjustment of the cowl in order to fit it perfectly to the spinner backplate.

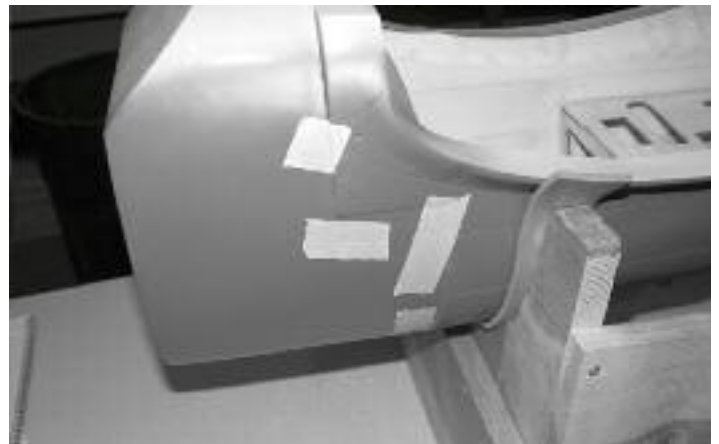

58. Once you are sure of the correct cowl alignment, drill $5/64$ " holes at various mounting locations (we drill 9 evenly spaced holes) around the cowl and into the fuselage.

59. Remove the cowl and engine box from the fuselage.

60. Place a piece of masking tape over the outside of each hole to keep epoxy that you will be using in the next step from leaking through onto the fuselage.

61. Use 100 grit sandpaper to lightly sand the inside of the fuselage around each hole that was drilled in the previous step. Clean the area with denatured alcohol. Preparing the fuselage this way will help the epoxy bond the wood cowl reinforcement blocks to the fuselage.

62. Locate the $3/4$ " x $3/8$ " x 12" hardwood stick and cut it into 1" lengths.

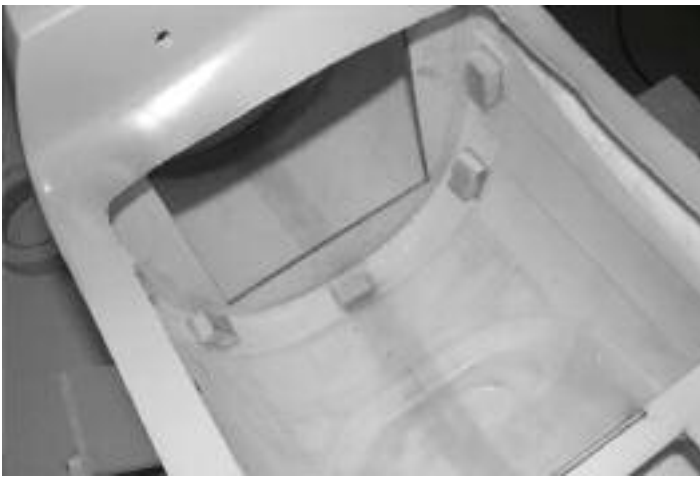

62. Use 5 min epoxy to attach a hardwood block to each hole location inside the fuselage. These will act as the screw backup when you attach the cowl. The reason you do this now is because after the firewall box is in place, you won't have access to this area - so make sure they are glued in place well!

63. When the epoxy has cured but it's still a little rubbery, remove the tape from the outside of the holes and use a 5/64" bit to drill each hole through the block.



64. Re-fit the engine box in the fuselage and attach the cowl with the provided #2 x 3/8" button head screws and plastic washers.

65. Attach the spinner backplate and prop to the engine and slide the engine in place so it is centered on the cowl opening and 1/8" from the front of the cowl.



66. Use medium CA to tack the back of the engine box in place.



67. Remove the spinner, prop and cowl and use the hardwood tri-stock and 5 min epoxy to secure the firewall in place. Place the tri-stock as shown. Note: you can also sand the front of the firewall where the tri-stock fits for better adhesion of the epoxy.

If you installed the cowl correctly, the firewall will automatically be aligned with the fuselage very close to the proper incidence. If you prefer, you can double check by using a square and make small adjustments as necessary.

- 68. Once the epoxy has cured, you can install the muffler, ignition, throttle servo and fuel tank/fill setup. You may need to sand a little off the firewall box in order to fit the muffler.

The throttle servo can either be installed on the firewall box or inside the fuselage on the servo tray. We have included a Sullivan flex rod and 2-56 clevises for servo tray mounting.

Elevator and Rudder Servo Installation

At this time, you must decide where you are going to mount the elevator and rudder servos. If you think you will need tail weight (we did with a 4 lb motor) then mounting them in the tail is the best choice. Otherwise, you can mount them in the center fuselage tray and use your choice of pushrods. (we used the Sullivan S170 Heavy Duty Flex rods secured to the ply formers on one of the prototypes). In the following section, we will detail the installation of servos in the tail.



- 69. Install two high torque servos in the forward most slots on the rear fuselage servo tray as shown. Note: You will need long control arms for these servos.



- 70. Note the location of the servo arm on the inside of the fuselage. Mark the location on the outside of the fuselage.

71. Use a rotary tool with a small bit to cut a slot in the fuselage at the marks made previously. The slot should be long enough so the control arm has room to move to full surface deflection. Our slots were 1-1/4" x 5/16". Note: An easy way to locate the servo arms is to shine a laser pointer at the inside of the fuselage at the servo arm location. You will be able to see the laser from the outside of the fuselage. Otherwise you can make a mark with a hobby knife or pin.



- 72. Connect the 4-40 ball link adapter to the control arm and install the arm on the servo.

73. Cut a 4-40 threaded rod in half, and thread a 4-40 nut onto one end. Thread that end into the ball link adapter.



- 74. Connect a 4-40 clevis to the control horn with the servo and control surface centered and cut the rod to length (it should fit completely in the threaded portion of the clevis). Mark the location of the clevis on the rod.



- 75. Remove the control arm/rod/clevis assembly and make another rod the same length for the other elevator half. Assemble both pushrods with a ball link adapter and 4-40 lock nut on one end and 4-40 clevis and lock nut on the other end.

Note: Instead of using the lock nuts, you can solder both clevises onto the 4-40 rods.

76. Install the second pushrod assembly onto a long servo arm.



77. Re-install the control arms on the servos and connect the clevises to the control horns. Adjust the length as necessary by threading the rod in or out of the plastic swivel link arm or clevis. Tighten the lock nuts and use thread locking compound to secure them in place.

78. Check to insure that both pushrods are connected to the same hole location on the control horns. Both elevators must move together at the same rate.



79. Measure and draw a line down the center of the vertical stab as shown.



80. Mark and drill three evenly spaced 1/8" hinge holes in the vertical stab.



81. Mark the the holes in the same location on the rudder and drill to 1/8". Note: You may want to cut a small slot in the beveled edge of the rudder at each hinge location to make drilling easier.

82. Open the first 1/8" of each hole on the vertical stab to 11/64" and the first 1/8" of each hole on the rudder to 3/16". This will allow the hinges to seat all the way.

83. Cut small slots on the beveled edge of the rudder as shown. The hinge point will be inset in the rudder and you will need the slots so the rudder can reach full deflection.

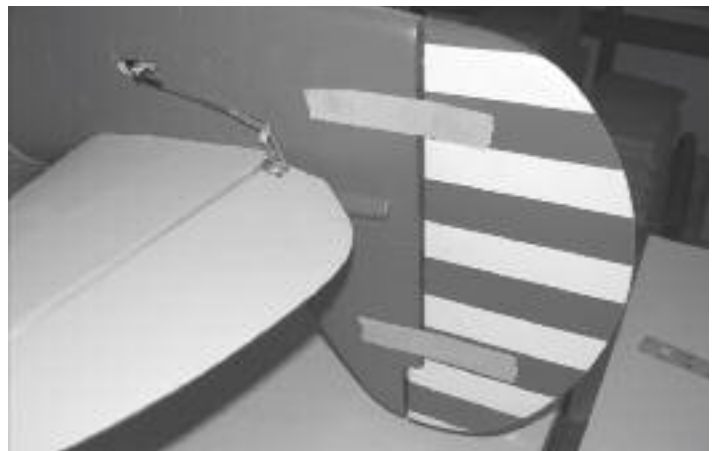

84. Test fit the hinges and rudder in place. Insure that the gap is less than 1/32". Epoxy the hinges in place like you did with the elevators and ailerons.



85. Measure 1-5/8" up from the bottom of the rudder and install a 1-1/8" control horn using the same method as the elevator horns.



86. Install a high torque metal gear servo in the rear fuselage tray on the opposite side as the rudder control horn.

87. Install a 4-40 swivel ball link connector on the rudder servo arm. Cut a piece of 4-40 threaded rod in half and thread one side into the ball link.

88. Cut a small slot in the rear fuselage 1-3/4" from the rear of the stabilize and 1-3/4" from the bottom of the fuselage to accommodate the rudder pushrod.



89. Measure and cut the rod to length using the same method as the elevator. Note: The servo arm will point towards the center of the fuselage and the pushrod will exit the fuselage on the opposite side as the servo. (see tail wheel retract photo)

90. Attach the ball joint/rod assembly to the rudder control horn and rudder servo.

Retractable Tail Gear



91. Align the tailwheel retract as shown. It should sit back at least 3/16" from the rear edge of the plywood mounting plate. Add a 2" tail wheel and check for servo clearance. Adjust the position as necessary for proper clearance.



92. Mark and drill four 3/32" mounting holes. Remove the retract and put a few drops of thin CA in each hole.

93. Install the airline per the manufacturers instructions and the enclosed 2-56 pull-pull control setup for steering. The servo will be mounted at any location in the center servo tray. You can use a Y-harness to connect the tail wheel servo to the rudder servo.

94. Fasten the tail retract in place using the enclosed #4 x 1/2" screws.

Main Retractable Gear

Before beginning your retract installation, it's a good idea to look inside the wing and insure that there is sufficient glue on the retract mounts and wing ribs. If you are unsure, you can reinforce the gear areas using 30 min epoxy.

At this time, you can also insure that the ailerons and flaps are functioning correctly. After you install the wheel well covers, it will be very difficult to get at the servo leads without major wing surgery!

For a more finished look, you can also make your own wheel well covers by fitting and gluing balsa or 1/16" ply to the insides of the wheel wells. You can then fiberglass and paint the wheel wells. We have matching paint available if you cannot find a matching color.

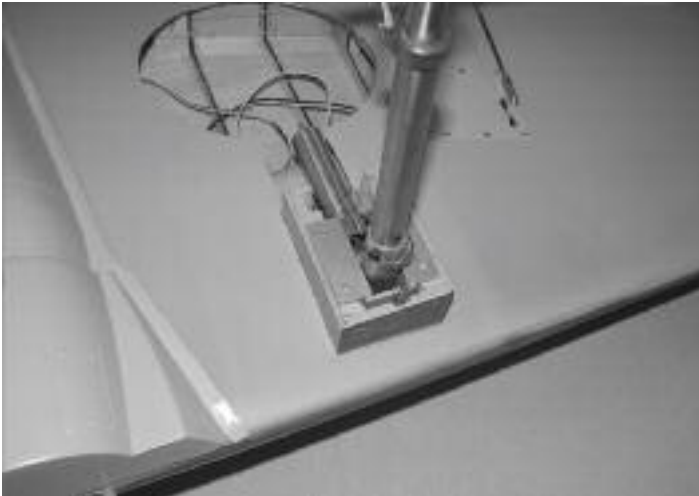
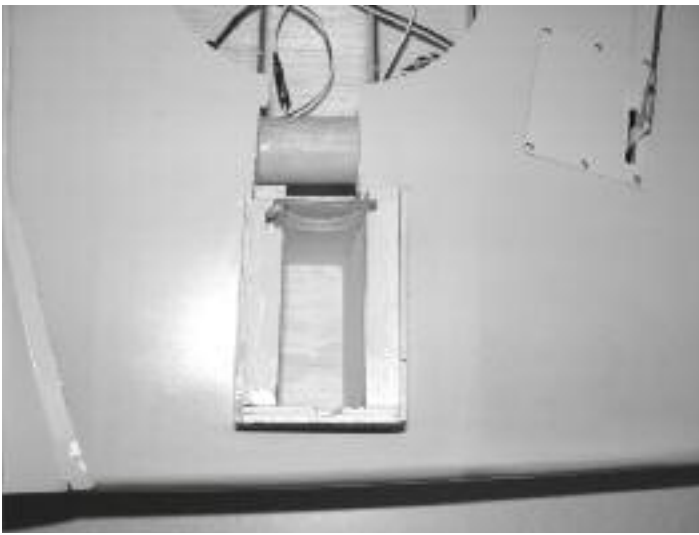

95. Attach the wheel to the retracts

96. Retract the gear and place them in the gear mounts so the wheel is centered in the wheel well. Note: You may need to use a rotary tool to modify the gear blocks slightly for the retract valves, etc. On the Century Jet retracts, we cut a slot in the front of the retract plate for the pin so the gear could be moved all the way forward.

97. Mark and drill mounting holes for each retract unit. Use the #6 x 3/4" wood screws to attach the retracts to the mounting rails. We use wood screws in case of a very bad landing, the screws will tear out instead of tearing apart the wing. Put a few drops of thin CA in each hole to reinforce them.

98. Connect the airlines to the retracts and run them through the holes in the center of the wing. You may need to drill holes through some of the wing ribs in order for the air hose to move freely.



99. Carefully cut the abs wheel well covers along the scribed lines and fit in place as shown. You will also need to drill holes in the cover so the airlines on the end of the cylinder can be routed into the wing. Note: You may need to cut slots in the ribs so you have room to fit the servo wires with the wheel well cover in place.

When cutting the wheel wells, it is best to cut outside the scribed lines and finish with a sanding tool. This will help prevent the plastic from cracking during cutting.



100. Mark a line around the wheel well covers and remove the covering in that area.

101. Mount the control valve in the fuselage and test the retracts to insure they operate correctly before you glue the wheel well covers. (we mounted the control valve on the center servo tray and used a mini servo to operate the valve)

102. Apply 5 min epoxy to the edges of the wheel well covers and fit in place. Place weights on the covers until the epoxy cures.



103. Correctly fit the fiberglass gear covers in place and mark their location on both sides of the wing. Small variations in the wing frame up may cause the gear pods to not fit exactly. You can use a heat gun to make small adjustments or cut the inside of the gear pods, along the gear mounts so they fit the wing correctly.

104. Sand the mounting surface of the gear pod with 100 grit sandpaper to remove any paint or mold release.

105. Poke a series of small holes in the covering like you did with the belly pan. (or you can remove the covering in the marked area) and use 5 min epoxy to glue the gear covers into place. Use masking tape to secure them while the epoxy cures.

Instrument Panel and Canopy



106. Locate the black instrument panel, clear gauge lens and paper gauge face.

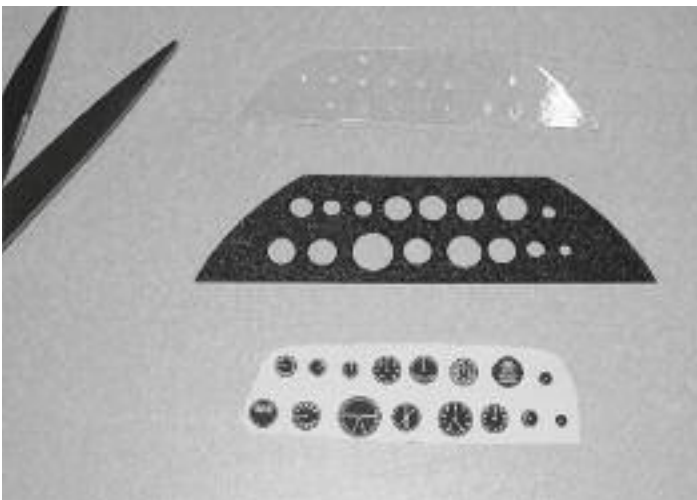

107. Cut the paper gauge face and clear lens piece to size as shown.



108. Use medium CA or 5 min epoxy to glue the clear lens piece to the back of the black panel.

109. Use medium CA to glue the paper gauge face to the clear lens piece. Make sure the gauges are aligned correctly. Note: Only use a small amount of CA otherwise you will fog the clear lens piece.



110. Use 5 min epoxy to glue the instrument panel to the cockpit.

111. You can also add a pilot of choice at this time.



112. Carefully cut the canopy along the formed lines and test fit on the fuselage.

113. Once you have achieved a good fit, apply a liberal amount of RC-56 or 5 min epoxy to the canopy and tape in place.

114. Wipe off any excess glue.

115. Apply the decals as shown on the enclosed 3-view drawing.

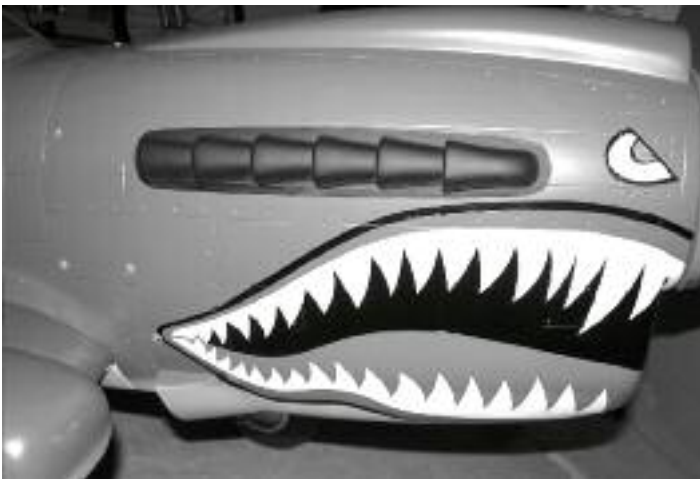

116. Carefully cut the exhaust stacks along the outside of the molded lines. Sand them along the molded lines and use 5 min epoxy to glue them in place as shown. Clean up any excess epoxy with denatured alcohol.

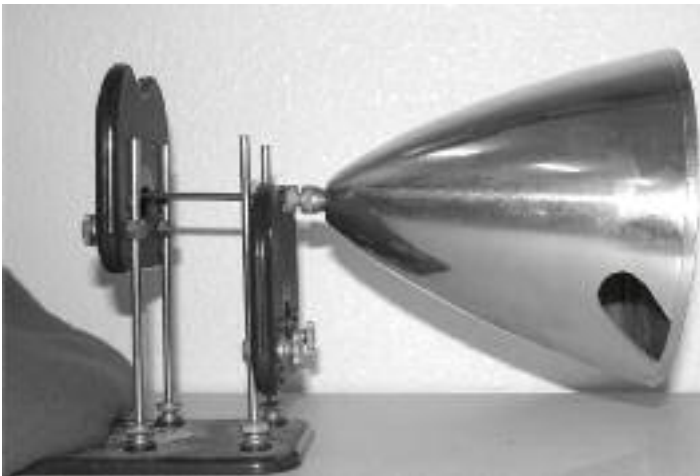

117. Balance the spinner by first painting it your preferred color (we used Krylon red).

118. Assemble the backplate and make a reference mark on the spinner and backplate so they can be aligned when the spinner is assembled on the plane.

119. Use a prop balancer to check the balance of the spinner and backplate. We fastened the prop balance adapter to the pointed end of the spinner.

120. To obtain the correct balance, you can drill holes in the backplate or use a rotary tool and grinder bit to grind the inside of spinner cone.

The bolt included with the spinner is 10-32 x 4". This bolt can be used with any Tru-Turn engine adapter.

Balancing the Aircraft

Set the center of gravity by turning the plane upside down with the gear in the retracted position.

Measure where the wing meets the fuselage

3-3/4" from the leading edge of the wing.

Add weight as necessary to achieve proper balance. Note: This is the forward most CG. You can gradually move it back as you become comfortable flying the plane.

Control Throws

Aileron

3/4" up and down

Elevator

1-1/2" up 1" down

Rudder

1-1/2" left and right

Flaps

2" down

Preflight checks

- Double check that all control surfaces are properly glued by pulling on them firmly.
- Insure that all control surfaces are operating in the correct direction with the proper control throws.
- Insure that all wheels turn freely and that the plane tracks straight down the runway. Adjust the wheels as necessary.
- Secure all bolts with thread locking compound. This will keep them from vibrating loose in flight.

Decal Placement



Wing (top and bottom)

